

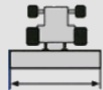







# **SERIE R** Hersees et semoirs pour tracteurs de 60 à 160 CV

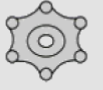

MODEL	 cm	 CV	 540 tr/mn 1000		 Nb	 cm	 Kg	 Kg	 Kg
R225S	225	60-90	221	305	9	25	750	760	880
R250S	250	70-130	221	305	10	25	800	820	950
R300S	300	100-160	221	305	12	25	890	900	1050

- Lame niveleuse arrière
- Prise de force avant et arrière
- Protection latérales oscillantes
- Boîte de changement de vitesse
- Rouleau cage, à pointes , packer

- Réglage rapide du rouleau arrière
- Largeur de travail de 2,25 à 3 m
- Éléments de sécurité CE
- Options
  - Pare-pierres soudé
  - Lame niveleuse frontale
  - Cardan cat 8 avec boulon de sécurité
  - Semoir
  - Fixation hydraulique du semoir avec 2 vérins



Protection latérale



Support hydraulique du semoir

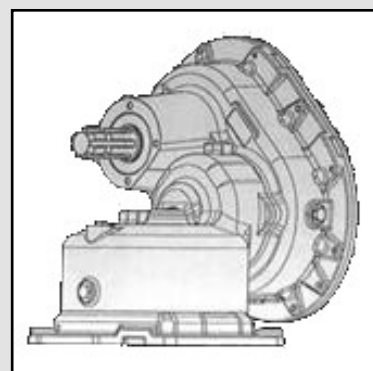

Boîte de vitesse





Rouleau à pointes



Rouleau packer

## Semoirs de 225 à 300 cm, tracteurs de 60 à 160 CV

	 (cm)	Encombrement (cm)	 (CV)	Capacité (L)	Nb de tubes de sortie
E225L	225	235	60-90	300	18
E250L	250	260	70-130	300	20
E300L	300 cm	309	100-160	400	24

- Montage en fixe sur la herse
- Tubes de sortie avec entraineurs individuels
- Protection latérales oscillantes
- Réglage de débit
- Commande d'arrêt du semis
- Réglage rapide du rouleau arrière
- Largeur de travail de 1,25 à 2,5 m
- Éléments de sécurité CE
- Options
  - Relevage hydraulique du semoir
  - Double trémie pour semence et engrais



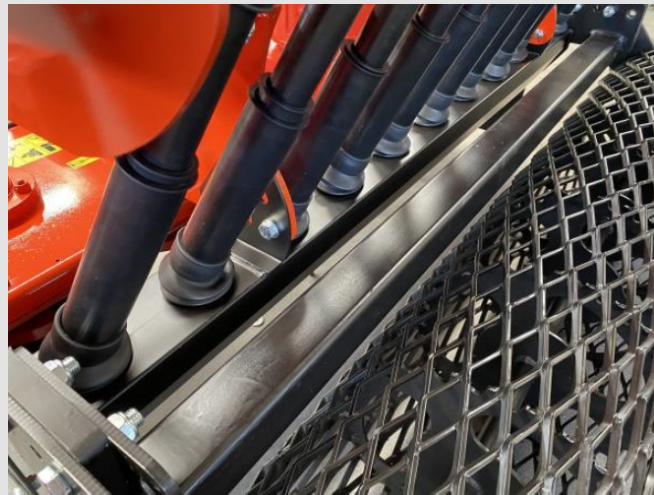

Entraineurs sur chaque tube de sortie

Votre revendeur

**KERSTEN**  
France

8 rue de la Gare - Lot N°8  
24290 Montignac Lascaux

[contact@kersten-france.fr](mailto:contact@kersten-france.fr)

[www.kersten-france.fr](http://www.kersten-france.fr)